

WWW.NORRMADE.COM

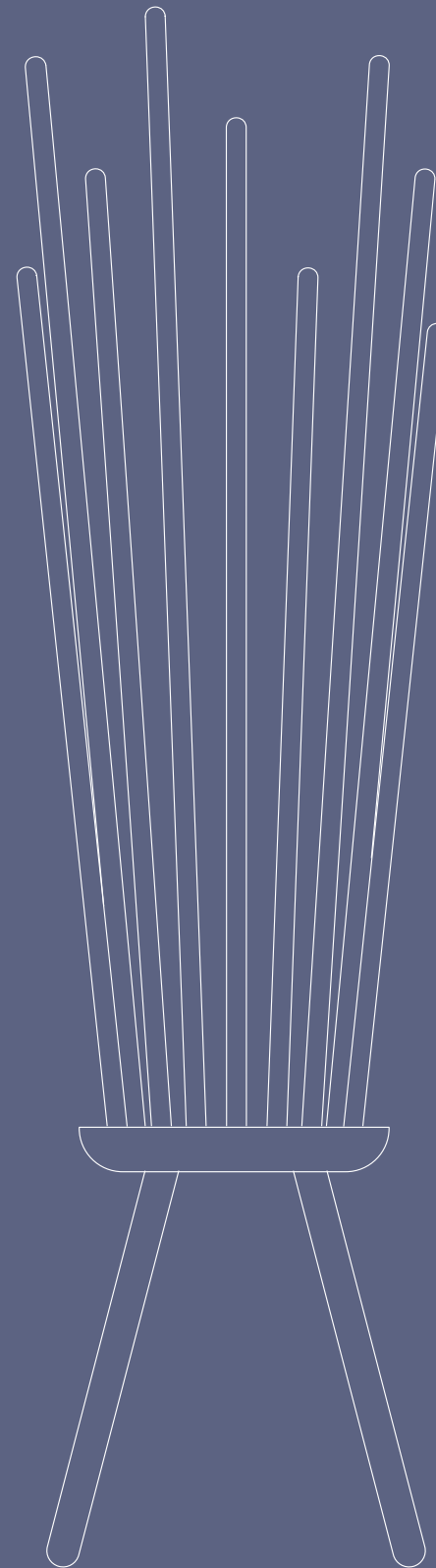
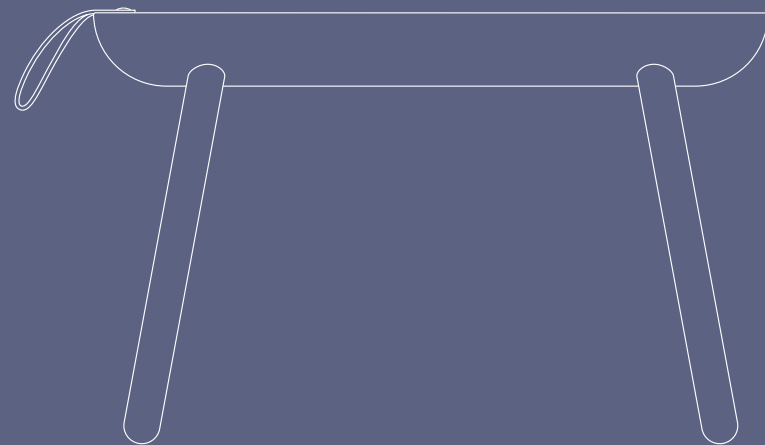

NORRMADE[®]
NORDIC SIGNATURE

Our roots

Our Scandinavian ancestors travelled north. They discovered a landscape of forests and sandy beaches, with bright and mild summers but harsh winters. They learnt modesty, to save valuable resources and to always rely on their common sense. The Scandinavian design tradition was born out of necessity, a way of thinking handed down over generations. And it is a tradition that will always be in fashion, because we are all modern-day nomads - the world is our home. And in this mix of cultures, we find peace in the uncomplicated and joy in the simple and functional. Our collection is designed for today's people. While Norrmade is looking to the world, our roots are solidly planted in the Nordic soil.



How we think

Our founding philosophy is to produce something that appeals to people in its own special way – giving something extra, without adding anything unnecessary. As a part of our approach to design we draw on nomadism – meaning to wander, to always be ready to move and to do so happily. Therefore our creations are designed to fit into different settings and be moved easily and they will be noted throughout the interior as spots that bring comfort and joy into our daily lives.







DISC
PIANO
DOUBLE
TRAPEZE
STICK
STANDBY
RAKE
WOODOO
SPOT
SHEEP
STEWARD
HIPPO
WEDGE
TRANSIT
PILGRIM
STEPS
BOTTLIGHT
ROPE
DONKEY
HANG SITT

DISC
PIANO
DOUBLE
TRAPEZE
STICK
STANDBY
RAKE
WOODOO
SPOT
SHEEP
STEWARD
HIPPO
WEDGE
TRANSIT
PILGRIM
STEPS
BOTTLIGHT
ROPE
DONKEY
HANG SITT





DISC
PIANO
DOUBLE
TRAPEZE
STICK
STANDBY
RAKE
WOODOO
SPOT
SHEEP
STEWARD
HIPPO
WEDGE
TRANSIT
PILGRIM
STEPS
BOTTLIGHT
ROPE
DONKEY
HANG SITT

DISC
PIANO
DOUBLE
TRAPEZE
STICK
STANDBY
RAKE
WOODOO
SPOT
SHEEP
STEWARD
HIPPO
WEDGE
TRANSIT
PILGRIM
STEPS
BOTTLIGHT
ROPE
DONKEY
HANG SITT





DISC
PIANO
DOUBLE
TRAPEZE
STICK
STANDBY
RAKE
WOODOO
SPOT
SHEEP
STEWARD
HIPPO
WEDGE
TRANSIT
PILGRIM
STEPS
BOTTLIGHT
ROPE
DONKEY
HANG SITT

DISC
PIANO
DOUBLE
TRAPEZE
STICK
STANDBY
RAKE
WOODOO
SPOT
SHEEP
STEWARD
HIPPO
WEDGE
TRANSIT
PILGRIM
STEPS
BOTTLIGHT
ROPE
DONKEY
HANG SITT





DISC
PIANO
DOUBLE
TRAPEZE
STICK
STANDBY
RAKE
WOODOO
SPOT
SHEEP
STEWARD
HIPPO
WEDGE
TRANSIT
PILGRIM
STEPS
BOTTLIGHT
ROPE
DONKEY
HANG SITT

the sheep bench

In the animal world a tail has many functions. One of them is to signal something with it. Sheep is asking to be pulled from one room to another where it can offer so many different ways of being used that it should be given the opportunity to do so.



SHEEP

Bench
Solid ash coated with clear oil
Seat in ash, black lacquered or 2.7 mm felt
Tail in leather
W:690mm x D:150mm x SH:440mm

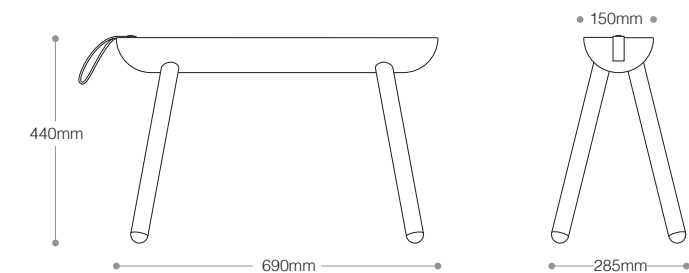

the wedge bench

The history of the triangular-shaped wedge goes back to when our ancestors began using hand axes and later when ancient Egyptians used it to carve blocks of stone for building. The list of uses is endless for the wedge. We want it to be seen and admired in our wedge bench - a tribute to a wonderful shape.



WEDGE

Bench
Solid ash coated with clear oil
Wedge part lacquered in red or black
W:700mm x D:220mm x H:440mm

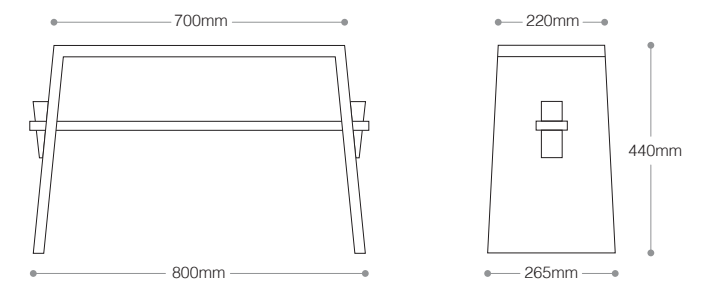

the transit bench

A stopover should be a pleasant experience and so too is Transit. To undo or tie one's laces in a relaxing position. A place where a bag can rest for a while. Transit is a new generation of shoe rack that takes the focus away from the shoes and instead towards being a welcoming bench that also has a back support, which can be used to get a relaxing lift-off from the seat.



TRANSIT

Bench
Lacquered ash veneer with solid legs
Back in solid polished steel and black
lacquered solid beech wood.
W:1000mm x D:400mm x SH:450mm

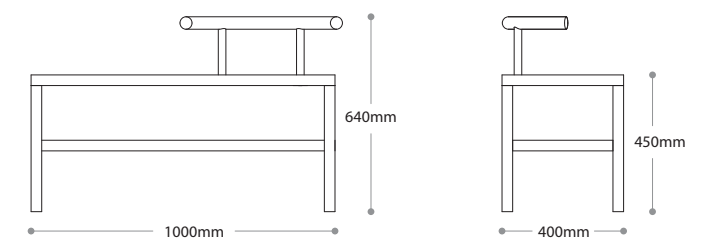

the stick shoe rack

A light-footed, minimalistic shoe rack with slim bars and a thin frame, doing what they are best at by raising the shoes above ground level and highlighting them in a light, floating way, giving them the place that they deserve after a long walk.



STICK

Shoe rack
Frame in solid lacquered ash
Shelves in black powder coated steel
W:540mm x D:295mm x H:860mm

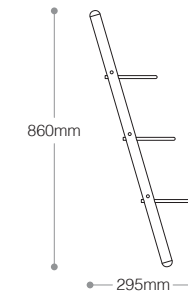
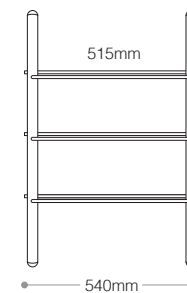



the steps shoe rack

The thin, black, steel shelves of the Steps lifts shoes up from the floor, giving them the air they need to keep them fresh and ready. Shoes are an important part of our daily lives and with a proper “parking space” they can be displayed at their best for the wearer, who can take pleasure in deciding which ones will be on the move for the day.



STEPS

Shoe rack
Frame in solid lacquered ash
Shelves in black powder coated steel
W:550/735mm x D:295mm x H:870mm

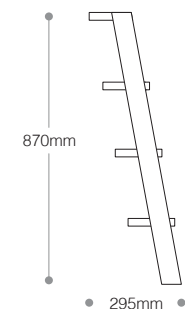
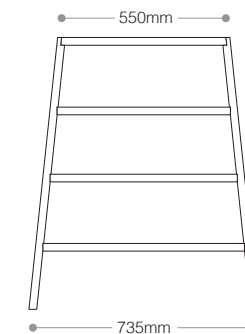

the hang sitt stool

A two-in-one functional stool. The seat is the perfect place to sit and tie one's shoes or place a bag, and the sticks will carry coats, bags and much more. The lower sticks are also designed to be used by children.



HANG-SITT

Coat rack with stool
Solid oak lacquered in natural
oak, white or black.
Seat Ø 315mm x H:1600mm SH:460mm

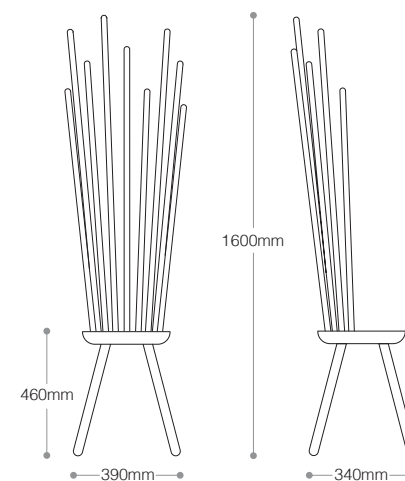

the rake hanger

Being an unique and historical garden tool that does wonders it deserves some rest from the hard gardening work. And there is no better place than a long-term rest on the wall, where it can wait as a confident and gentle character ready to serve you.

RAKE

Coat rack
Stick in solid ash coated with clear oil.
Rack in stainless steel
W:510mm x H:1600mm

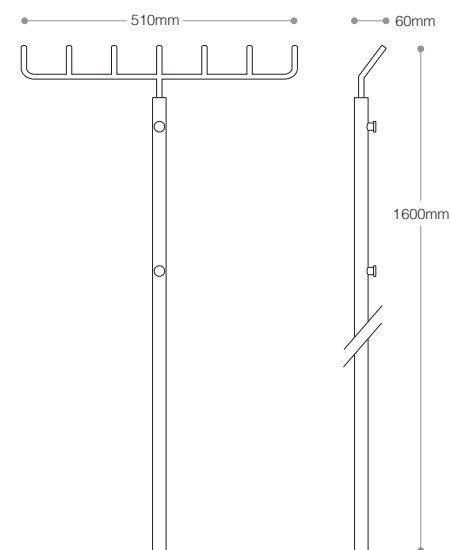

the piano hanger

Being 11mm thick Piano is probably one of the thinnest coat hooks that can be found. With hooks that bounce back like piano keys it always has a calm surface when not in use, and like a piano it is always ready for action.



PIANO

Rack with 5 hooks
Solid aluminum for the back plate
and hooks anodized in black
W:650mm x H:85mm x D:11mm

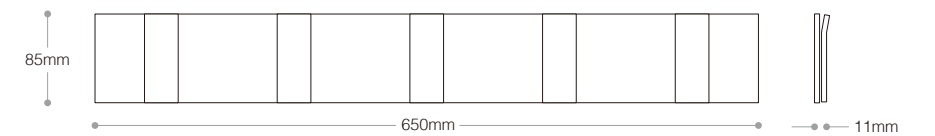

the disc hanger

All kinds of discs are a part of our daily lives, and the disc on the wall can be too. Maybe it will lead someone to wonder, observe and finally come with a little smile when the mystery of the magical disc is solved.



DISC

Coat hook
Diameter 87mm x D:12mm
Circular brushed aluminum hook and black anodized back plate.

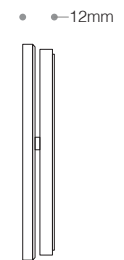
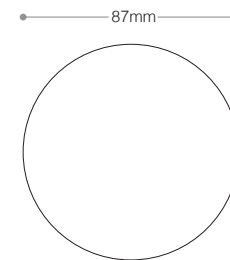



the spot mirror

A mirror is often not there when it is needed and often it is only needed for quickly checking something. Spot provides the possibility of having more mirrors on the walls while taking little notice of it being a mirror. The functional coat hook offers an opportunity for it to blend naturally together with the existing interior.



SPOT

Glass mirror
Diameter of glass 120mm
Hook in Ø 40mm black or white
powder coated steel.

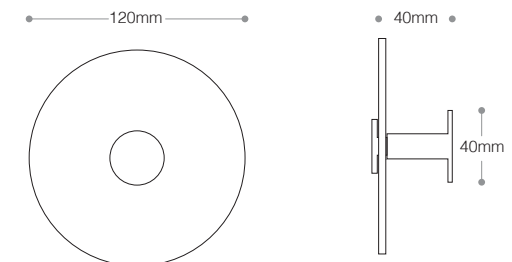

the double hanger

The Double is a two-in-one coat hook that not only gives the opportunity to use the two hooks at the same time but also allows the largest of the circular hooks to show its features while the front hook is being used.



DOUBLE

Coat hook
 Ø 125mm and outer coat
 hook Ø 45mm in lacquered ash
 Ash/black or black/ash

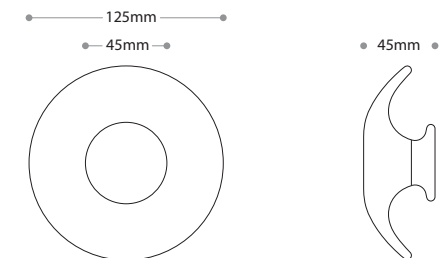

the standby rack

With a 3D-look, Standby is a new generation of functional clothes rack that offers a wide variety of positions and, when not needed, can be folded away or taken apart within a few seconds. Besides being practical, Standby also offers the pleasure of viewing one's personal belongings in a different way.



STANDBY

Clothes rack
Stainless steel in 19mm
Rubber thread in 3mm
W:430/450/470mm x H:1500mm

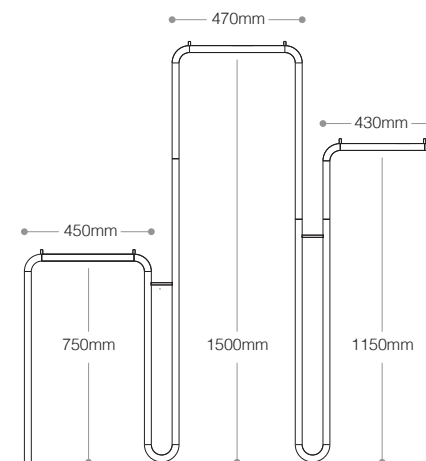

the steward

side table

In the 18th century the étagère, a French word became popular with its series of stages or shelves for displaying small articles, and it was quickly found on the dining table full with cakes, fruits and all other kinds of foods. This has been the inspiration and the Steward is an oversized étagère that is in direct connection with the floor and, due to its tall height, is always within easy reach.



STEWARD 2

Two-tier table
White or black powder coated steel
Table top H:565mm x W:370/495mm

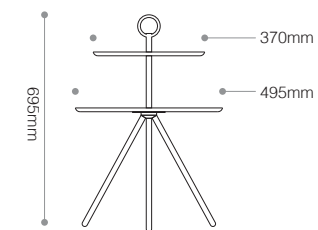

the steward

side table

In the 18th century the *étagère*, a French word became popular with its series of stages or shelves for displaying small articles, and it was quickly found on the dining table full with cakes, fruits and all other kinds of foods. This has been the inspiration and the Steward is an oversized *étagère* that is in direct connection with the floor and, due to its tall height, is always within easy reach.



STEWARD 3
 Three-tier table
 White or black powder coated steel
 Table top: H:770mm x W:265/370/495mm

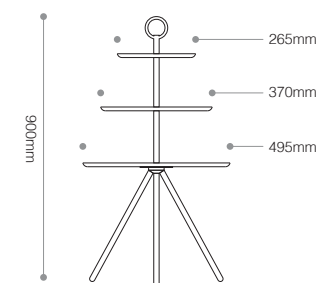

the pilgrim stool

A true nomad. Nomadism design is what we like to call it. A Pilgrim that is always ready to travel. The handle of the stool is waiting for a firm grip, for it to be lifted into another room. Pilgrim is a stool that is easy to move no matter how far the destination may be.



PILGRIM

Stool
White and black lacquered ash
Handle in polished steel
Diameter 290mm x H:460/550mm

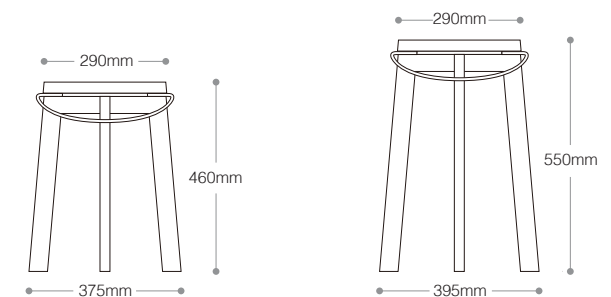



the pilgrim table

A true nomad. Nomadism design is what we like to call it. A Pilgrim that is always ready to travel. The handle of the stool is waiting for a firm grip, for it to be lifted into another room. Pilgrim is a stool that is easy to move no matter how far the destination may be.



PILGRIM

Side Table
White and black lacquered ash
Handle in polished steel.
Ø 410mm x H:500mm

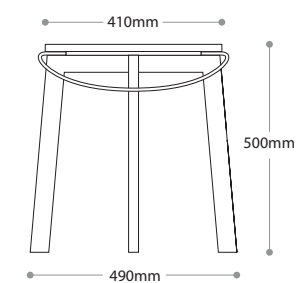

the hippo storage

A hippo has short legs and so too does our Hippo storage box. Its low height challenges the regular dimensions of interior items but that is what works for the Hippo, making it welcoming regardless of where it is placed. Being not too high or too low, there are many possible uses for the Hippo and therefore the only boundary is your imagination. One idea could be to make your own coffee table by placing a large book on top of the Hippo.



HIPPO SMALL

Storage
Legs in ash coated with clear oil
Box in black powder coated steel
W:500mm x D:300mm x H:470mm

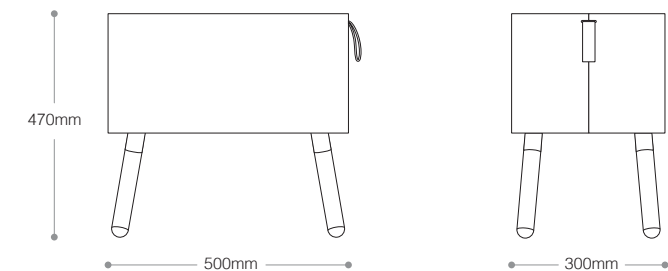

the hippo storage

Firewood has somehow always been grounded to the floor, but not with the Hippo as it stands with its short legs at the perfect height, its load of firewood in comfortable reach and at a height giving a good balance with the fireplace or the stove. Its strong, reinforced body is ready to take the constant load of the firewood.



HIPPO LARGE

Storage for firewood
Legs in ash coated with clear oil
Box in black powder coated steel
W:500mm x D:370mm x H:470mm

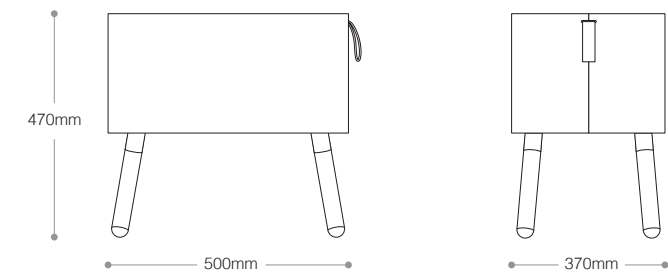

the donkey trolley

For thousands of years the donkey has been a working animal, only needing a gentle pull to get on the move. It is not a question of speed for the Donkey, moving steadily is what counts. Whether it's the dining table, the bedside or wherever, the Donkey soon arrives with what is needed, bringing pleasure into our lives.



DONKEY

Trolley
Fixed-mounted trays in black powder coated steel
Legs in ash coated with clear oil
H:800mm x W:580mm x D:370mm

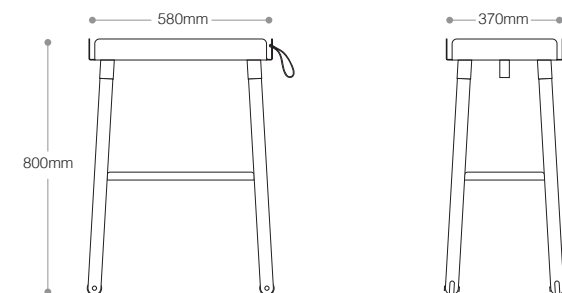

the Woodoo easy chair

A total of sixteen sticks create the circular back of the Woodoo. These are needed to give width and depth, and with this the freedom to move around in the chair. The Woodoo appeals to those who are not satisfied with just one position when seated. The pillows can be used in multiple ways for additional comfort and the character of the chair also invites the use of whatever pillows may be nearby.



WOODOO

Easy chair
Frame in solid lacquered ash
Upholstery in fabric
W:910mm for sticks W:770mm for seat
H:660mm D:740mm SH:390mm

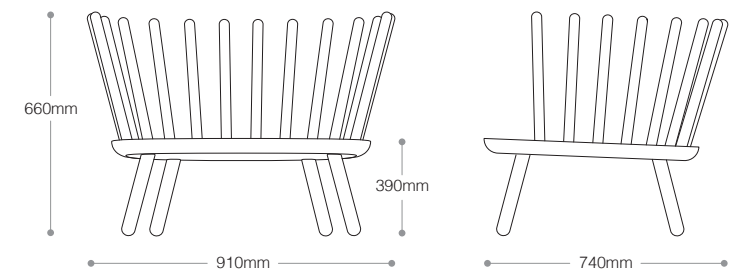

the trapeze shelf

The design of this shelf is based on the same principle as the trapeze found in gymnastics or a rope ladder, and in the same way the webbing stretches out and it is immediately ready to be mounted on the wall when pulled out of its box. Its small size allows it to be used in many different wall settings, as the space around it gives the Trapeze the effortless look that it deserves.



TRAPEZE

Shelf
Lacquered shelves in 9mm solid ash
Polyester webbing in 35mm width.
W:600mm x D:150mm x H:630mm

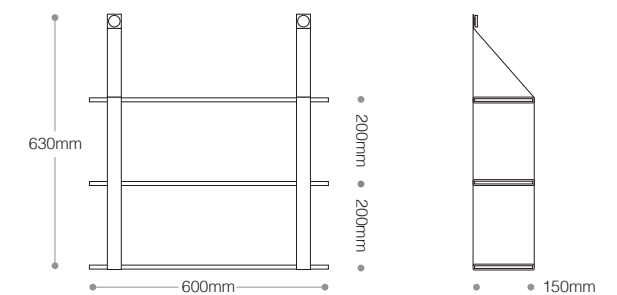



the rope mirror

Out of the many hundreds of knots that exist the "cow hitch" is one of the very few knots that, with its regular features, shows harmony and beauty. In many places around the world it is still used when lifting barrels, and now the time has also come for it to lift something else. A welcome to the indoors for the cow hitch.



ROPE

Glass mirror
 Ø 300mm - 8mm thickness
 10mm rusty red & black
 silicone o-ring included in box
 Stainless solid wall hook

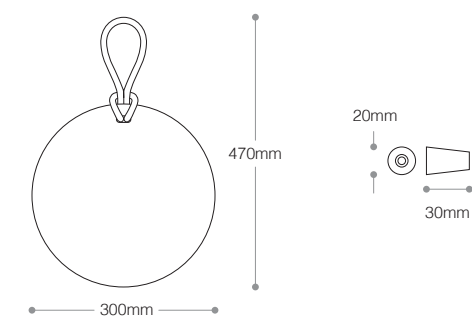

the bottlight candle holder

For some cultures tea-light candles are a vital part of both the indoor and outdoor decoration and no other type of candle has such a multi-purpose function. Since it is always needed, it must therefore be easily accessible. Bottlight is like a cartridge – waiting and ready for the next one to be fired up !



BOTTLIGHT

Tealight candle holder
Smoked glass with top in
polished stainless steel
W:119mm x H:129mm

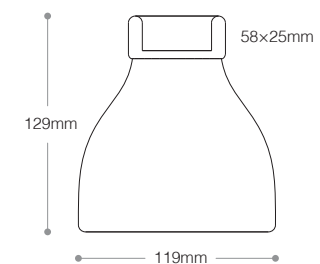



Showroom

Our showroom is located in the town of Fredensborg, north of Copenhagen, where the Danish queen also resides. Our collection is on display a short distance from her castle, at a historic house that was previously an old jail and court house from 1857. The old cells and hall area are preserved as they were more the 150 years ago, but now serve to showcase our furniture, providing a contrast to the old that cannot be explained in either words or pictures.

NORRMADE®

Tinghusvej 13
3480 Fredensborg
Denmark
phone: +45 20268518
WWW.NORRMADE.COM

Designers

We have attempted to go back to the roots and found inspiration in the simple things in our Nordic surroundings. Furniture and objects that are sincere, that do not pretend to be more than they are. In this way one can see and appreciate the thoughts that formed them.

Products of the past gained their form out of a particular need, in a time when superficial products did not exist because only those that were necessary had the right to exist. This is a strong and sustainable philosophy – not a limitation but an inspiration, which reminds us that the products we create must function in our everyday lives and satisfy people for many years to come.

DESIGN BY TOOLS®
HENRIK HOLBÆK & CLAUD JENSEN

